

P CUBE evolution series Cutting Machines are designed as per European safety standards.

Each part in this model of cutting machine is designed with the advanced software with a goal to make the machine rugged, stronger & maintenance free.

The gears and all moving parts are made with hardened and wear resistance steel.

We use double stage of helical gearbox design, which helps in reducing speed and improving the life of blades vastly.

This series is designed with the higher factor of safety to increase the life of machine up to 10 years.

In evolution series cutting machines, main body and other parts are supplied with Powder Coated finish which increases the shell life and gives the protection against rust.

Minimum vibration and less noise while cutting bars, because of Dynamically balanced flywheel, thereby ensuring the long life of moving parts.

These machines are provided with wheels for the easy movement at site.

The cutting blades are made from special hardened steel & designed to cut small and big diameter steel rods.

In evolution series cutting machines, all the four edges of cutting blades can be used.

BAR CUTTING MACHINE SPECIFICATIONS

MODEL	Stroke Per Min.	Ø Max. 75 Kg./mm ²	No. of Bars	Motor Kw (HP)	Dimensions (mm)	Weight (Kgs.)
PCM42*	87	Ø32	1	3.7 (5)	540 x 1050 x 875(h)	425
		Ø20	2			
		Ø12	3			
PCM52	58	Ø36	1	3.7 (5)	745 x 1180 x 1015(h)	580
		Ø32	2			
		Ø16	3			
PCM55	56	Ø42	1	5.5 (7.5)	775 x 1290 x 1100(h)	875
		Ø30	2			
		Ø25	3			

Please Note : The Wheels are not supplied with* Marked models.

BAR BENDING MACHINE



P CUBE evolution series Bending Machines are designed as per European safety standards.

In evolution series Bending machines, we use customized European planetary gear box, coupled with the motor, which eliminates the use of “V” belts to eliminate the breakdown.

The use of customized European planetary gear box gives the higher torque and increases the productivity.

We manufacture sheet metal body parts for these New evolution series machines on CNC punching and bending.

We use advanced CNC Laser cutting, CNC turning and VMC for manufacturing parts, which are in-house Facility.

In evolution series Bending machines, All the pins, bushes & rollers are electroplated for the protection against rust & better magnificent quality.

Evolution series is specially designed with electrical braking circuit which safely stops the motor, and eliminates the need of Brake motor, thus, reducing the breakdown and maintenance of changing the brake liners.

In evolution series, standard Schneider make Electrical contactors and Finder (Italian) make timers are used, which reduce the Frequency of electrical breakdowns.

Evolution series machines are supplied with the expensive synthetic oil for Italian gear box which eliminates the frequent change of oil and increases the life of the gear components.

BAR BENDING MACHINE SPECIFICATIONS

MODEL	rpm.	Ø Max. 75 Kg./mm ²	No. of Bars	Motor Kw (HP)	Bend Wheel Dia. (mm)	Dimensions (mm)	Weight (Kgs.)	Max Bend Radius (mm)	Bush Size (mm)
PBM42	10	Ø32	1	3 (4)	350	715 x 1000 x 1040(h)	325	4D of Ø25 3D of Ø32	Ø60,Ø70, Ø100
		Ø20	2						
		Ø12	3						
PBM52	10	Ø36	1	3.7 (5)	425	815 x 1100 x 1070(h)	367	5D of Ø32 4D of Ø36	Ø60,Ø70, Ø100, Ø120,Ø160
		Ø32	2						
		Ø16	3						
PBM55	8	Ø42	1	5.5 (7.5)	500	925 x 1210 1200(h)	545	6D of Ø36 5D of Ø42	Ø60,Ø70, Ø100, Ø120,Ø160, Ø220
		Ø30	2						
		Ø25	3						

Optional : 8D of Ø42 (Ø320 Bush Size)

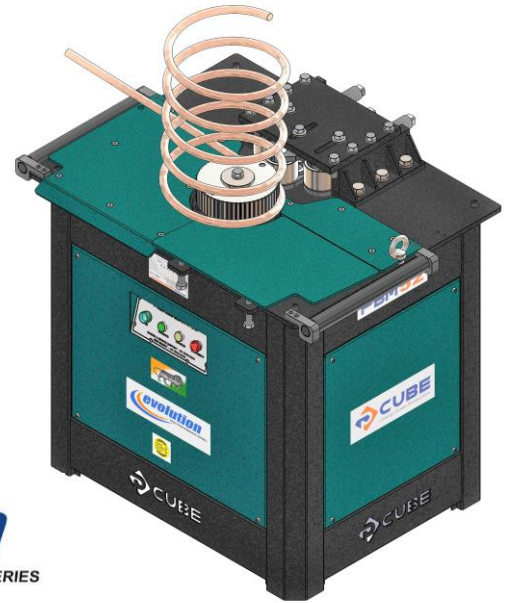
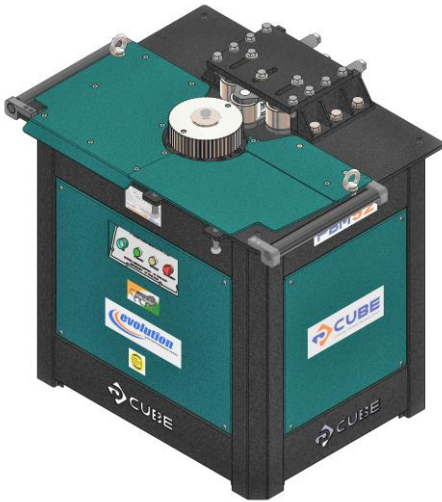

TMT Bar Spiral Bending Machine is purposely designed for the formation of spirals with boundless maximum diameters.

Extremely robust TMT bar Spiral bending machines produce spirals from 310 to 1800 mm diameter with rod size 6 to 25mm.

P CUBE evolution series Spiral bending machines are designed as per European safety standards.

Spiral bending machine's all the rollers and jack screws are electroplated for the protection against rust and better magnificent quality.

We use customized European planetary gear box which gives the higher torque and increases the productivity.

In **P CUBE** Spiral bending machines, use of customized European planetary gear box, coupled with the motor, eliminates the use of "V" belts to eliminate the breakdown.

We manufacture sheet metal body parts for these New **P CUBE** machines on CNC punching and bending.

We use advanced CNC Laser cutting, CNC turning and VMC for manufacturing parts, which are in-house Facility.

In **P CUBE**, standard Schneider make Electrical contactors and Finder (Italian) make timers are used, which reduce the Frequency of electrical breakdowns.

P CUBE machines are supplied with the expensive synthetic oil for European gear box which eliminates the frequent change of oil and increases the life of the gear components.

TMT SPIRAL BENDING MACHINE SPECIFICATIONS

MODEL	RPM	Motor Kw (HP)	Dimension Size (mm)	Weight (kg.)			
PSB52	10	1 X 3.7 (5)	880 x 1060 x 1020(h)	355			
BENDING CAPACITY							
Dia. Of Bar (mm)	6	8	10	12	16	20	22
Ring Dia. Min (mm)	310	310	310	400	400	400	500

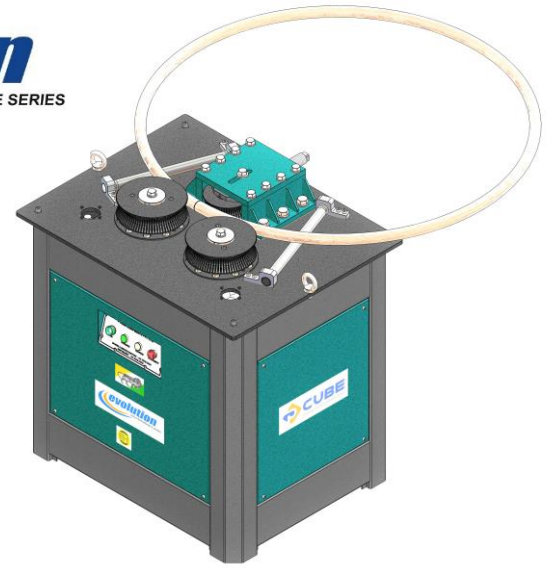
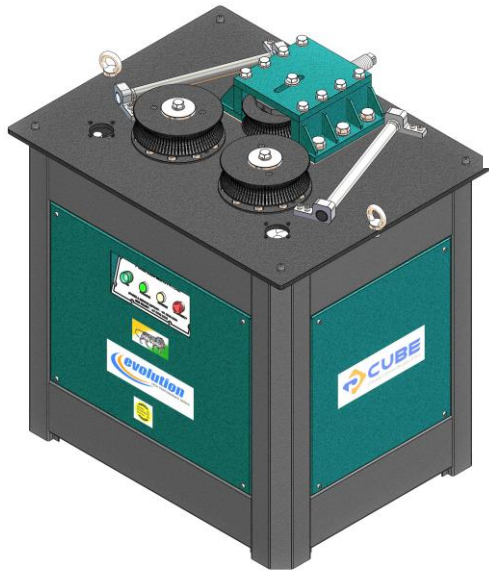

TMT Bar Ring Bending Machine is purposely designed for the formation of spirals with boundless maximum diameters.

Extremely robust **TMT Bar Ring Bending Machines** produce the Rings from 450 to 4000 mm diameter with rod size 20 to 42 mm.

P CUBE evolution series Ring bending machines are designed as per European safety standards.

Ring Bending machine's all the rollers and jack screws are electroplated for the protection against rust and better magnificent quality.

We use customized European planetary gear box which gives the higher torque and increases the productivity.

In **P CUBE** Ring bending machines, use of customized European planetary gear box, coupled with the motor, eliminates the use of "V" belts to eliminate the breakdown.

We manufacture sheet metal body parts for these New **P CUBE** machines on CNC punching and bending.

We use advanced CNC Laser cutting, CNC turning and VMC for manufacturing parts, which are in-house Facility.

In **P CUBE**, standard Schneider make Electrical contactors and Finder (Italian) make timers are used, which reduce the Frequency of electrical breakdowns.

P CUBE machines are supplied with the expensive synthetic oil for European gear box which eliminates the frequent change of oil and increases the life of the gear components.

TMT RING BENDING MACHINE SPECIFICATIONS

MODEL	RPM	Motor Kw (HP)	Dimension Size (mm)	Weight (kg.)		
PRB55	10	2 X 3.7 (5)	880 x 1060 x 1020(h)	450		
BENDING CAPACITY						
Dia. Of Bar (mm)	20	25	30	32	36	42
Ring Dia. Min (mm)	500	550	600	650	750	800



Evolution
 HIGH PERFORMANCE SERIES

STANDARD ELECTRICAL SAFETIES

- Interlocking devices on cage doors, enclosure doors,
- Top / Bottom limits
- Over travel final limits for top / bottom ends
- Erection platform interlocking device
- Cable jamming protection device
- Rebar unit position limit
- Top, bottom and emergency stops
- Rack searching device
- Emergency stop (on car, control boxes, Base panels, etc.)
- Power supply main switch
- Safety device actuation detector

STANDARD MECHANICAL SAFETIES

- 2 Motors with gearbox and electromechanical brakes
- Safety device
- Floating motor plate
- Bottom mechanical stops with buffers
- Anti slippery floor
- Motor protecting cover
- Hand release break for Emergency reach to nearest lower floor.

GENERAL DATA

MODEL	PM100	PM150	PM200
Capacity	1000 KG	1500 KG	2000 KG
Speed	30 Mtr./ Min.	30 Mtr./ Min.	30 Mtr./ Min.
Height	150Mtr.	150 Mtr.	150 Mtr.
Gear Rack Module	5	5	5
Safety Device	PSD 1000	PSD 3500	PSD 3500
Mast section	Square 450 x 450mm x 1.5m Round tube Ø60 x 4.5 Thk.	Square 450 x 450mm x 1.5m Round tube Ø60 x 4.5 Thk.	Square 450 x 450mm x 1.5m Round tube Ø60 x 4.5 Thk.
Wall tie interval	6 Mtr.	6 Mtr.	6 Mtr.
Cable Guide Interval	6 Mtr.	6 Mtr.	6 Mtr.
Rect. Cage. (Inside)	2.0 (L) x 1.4 (W) x 2.1 (H) mtr.	2.5 (L) x 1.4 (W) x 2.1 (H) mtr.	3.0 (L) x 1.4 (W) x 2.1 (H) mtr.
Erection Crane	Yes, Electrical	Yes, Electrical	Yes, Electrical
HMI Display	Yes (Colour)	Yes (Colour)	Yes (Colour)
Floor Selection	Yes (Optional)	Yes (Optional)	Yes (Optional)
Load Cell	Yes (Optional)	Yes (Optional)	Yes (Optional)

ELECTRICAL DATA

Motor Power	2 x 6.9 KW	2 x 9.5 KW	3 x 9.5 KW
VFD	15 KW	22 KW	30 KW
Power Supply	400V (±5%) 50 Hz	400V (±5%) 50 Hz	400V (±5%) 50 Hz

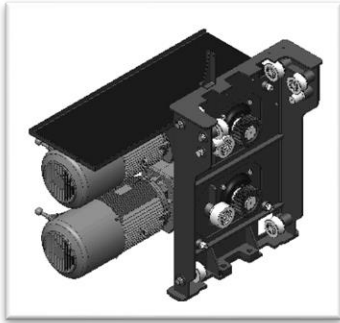

• DRIVE UNIT

The drive unit consists of Two Helical-bevel gearboxes with motors and It is located usually above the hoist cage. The drive unit pinions are engaged with the rack on the mast. The motors are equipped with electromagnetic disc brakes which can be equipped with VFD, that improves the ride quality and leveling precision because of smooth starts and stops. The **Powder coated** finish increases the shell life of structure and gives the high end protection against the rust.

• CAGE UNIT

The cage is welded of quality steel profile which is made of Sheetmetal with the use of modern manufacturing technologies. Side walls are covered with CR sheeting with perforation. The entry and exit doors can slide vertically and their closing is checked with electrical Safety Switch. There are also entry door electromechanical locks and can only be opened when the cage is at a ground. Guide rollers ensure the accurate motion of the cage along with the mast. The **Powder coated** finish increases the shell life of the structure and gives the high end protection against the rust.

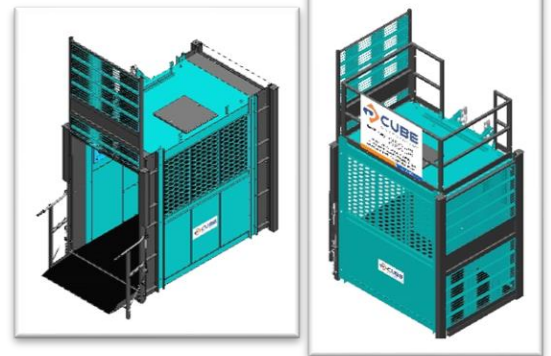

• SAFETY DEVICE

All **P CUBE** rack & pinion hoists are supplied with **European Design Safety Device** compliances with the **EN12159** and the **95/16/EC** directives of the **European Parliament and Council**. The safety device is an essential part of each rack & pinion hoist equipment, designed to safely stop the machine if the nominal speed is exceeded while coming down. The safety heart of this device is a centrifugal mechanism, Which is individually and accurately set for a particular machine model.

• CONTROL PANELS AND LIMIT SWITCHES

The installed electrical components and limit switches ensure a safe and trouble-free operation. **P CUBE** supplying Schneider, Finder and equivalent Premium and Reliable brand electrical contactors, relays, MCBs etc. to avoid damage of electrical motor. Thus reducing frequency of electrical breakdowns. The control panels are well arranged and all the components are made to comply with IP 54 protection.

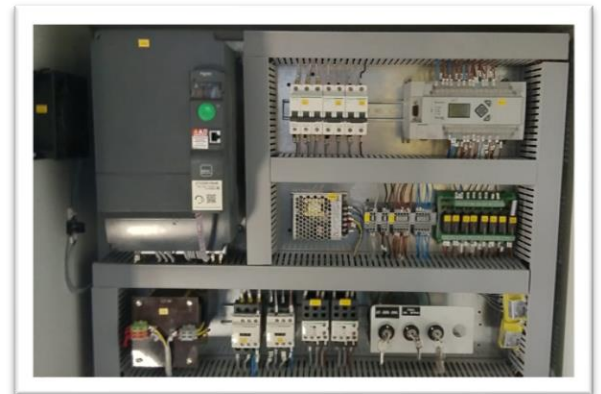

• HOIST CONTROL

The hoist can be controlled in several ways to meet the requirements and practices of customers. The control systems are:

1. **Manual:** The most simple way. The hoist can be operated by simple manual control.
2. **Automatic:** The hoist can be controlled not only from the cage by the means of pushbuttons or a joystick, but also from the Colour HMI display.

We supply Schneider / Mitsubishi make Premium brand VFD, which delivers trouble free performance. Colour HMI, which displays the real time status of machine and indicates the error messages with proper images. Encoder to be provided for accurate floor selection during auto mode, which also shows us the real time floor position of machine on HMI screen. It Provides all required safety elements. The car overload protection device prevents overload of cage beyond its rated load capacity. Encoder based floor selection system enabling cage to stop at any number of floors as per the requirement.

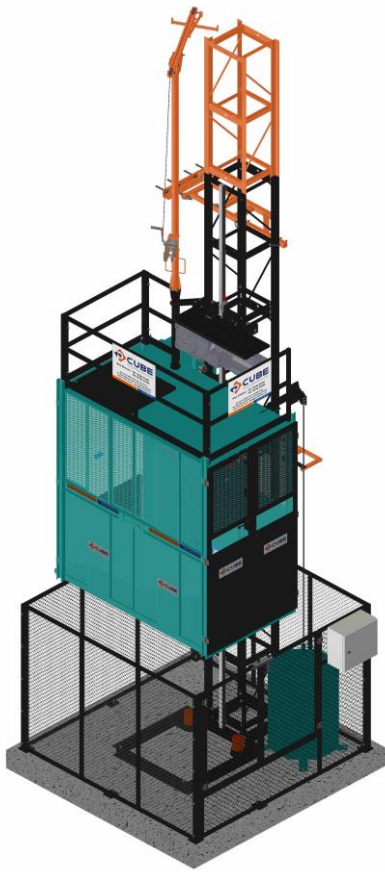

Evolution
HIGH PERFORMANCE SERIES

STANDARD ELECTRICAL SAFETIES

- Interlocking devices on cage doors, enclosure doors,
- Top / Bottom limits
- Over travel final limits for top / bottom ends
- emergency stops
- Rack searching limit
- Emergency stop (on car, control box, etc.)
- Power supply main switch
- Safety device actuation detector

STANDARD MECHANICAL SAFETIES

- Motor with gearbox and electromechanical brake
- Safety device
- Bottom mechanical stops with buffers
- Anti slippery floor
- Motor protecting cover
- Hand release break for Emergency reach to the nearest lower floor.

GENERAL DATA

MODEL	PMT80
Capacity	800 KG
Speed	30 Mtr./ Min.
Height	120 Mtr.
Gear Rack Module	5
Safety Device	PSD 1000
Mast Section	Square 500 mm x 400 mm x 1.5 Mtr. Angle L 50x50x6 mm
Wall Tie Interval	3 Mtr.
Cable Guide Interval	6 Mtr.
Rect. Cage. (Inside)	1.8 (L) x 1.0 (W) x 2.0 (H) mtr.
Erection Crane	Yes, Manual
HMI Display	Yes (Colour)
Floor Selection	Yes (Optional)
Load Cell	Yes (Optional)

ELECTRICAL DATA

Motor Power	1 x 9.5 KW
VFD	11 KW
Power Supply	400V (±5%) 50 Hz

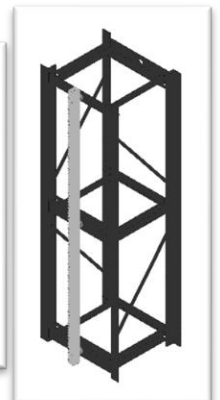
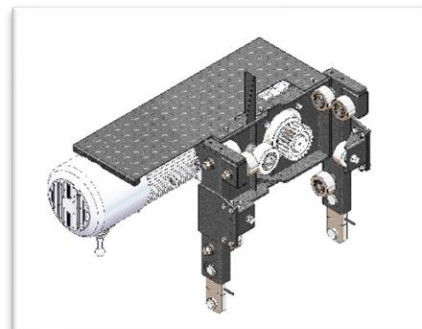

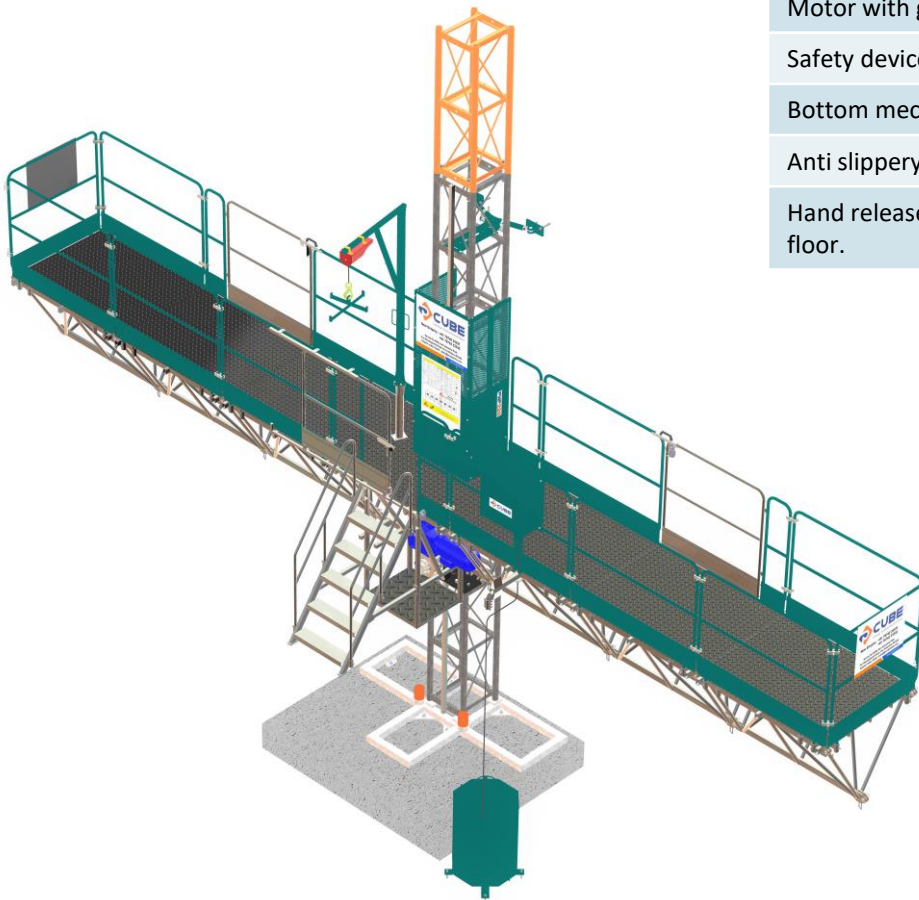

STANDARD MECHANICAL SAFETIES

Motor with gearbox and electromechanical brakes

Safety device

Bottom mechanical stops with buffers

Anti slippery floor

Hand release break for Emergency reach to the nearest lower floor.

STANDARD ELECTRICAL SAFETIES

Interlocking devices on cage doors

Top / Bottom limits

Over travel final limits for top / bottom ends

Cable jamming protection device

Emergency stops

Rack searching device

Power supply main switch

Safety device actuation detector



GENERAL DATA

MODEL	PWP 150	PWP 220
Capacity	1500 KG	2200 KG
Platform Length	4.5 m – 7.5 m	4.5 m – 10.5 m
Platform Width	1.2 m	1.2 m
Overhang	3.0 m	4.5 m
Speed	7-10 Mtr./ Min.	7-10 Mtr./ Min.
Height	120 Mtr.	120 Mtr.
Gear Rack Module	5	5
Safety Device	Yes (European Design)	Yes (European Design)
Mast section	Square 500 mm x 400 mm x 1.5 Mtr. Angle L 50x50x6 mm Angle	Square 500 mm x 400 mm x 1.5 Mtr. Angle L 50x50x6 mm Angle
Wall Tie Interval	3 Mtr.	3 Mtr.
Cable Guide Interval	6 Mtr.	6 Mtr.

ELECTRICAL DATA

Motor Power	1 x 5.5 KW	2 x 4.0 KW
VFD	7.5 KW	11 KW
Power Supply	400V (±5%) 50 Hz	400V (±5%) 50 Hz

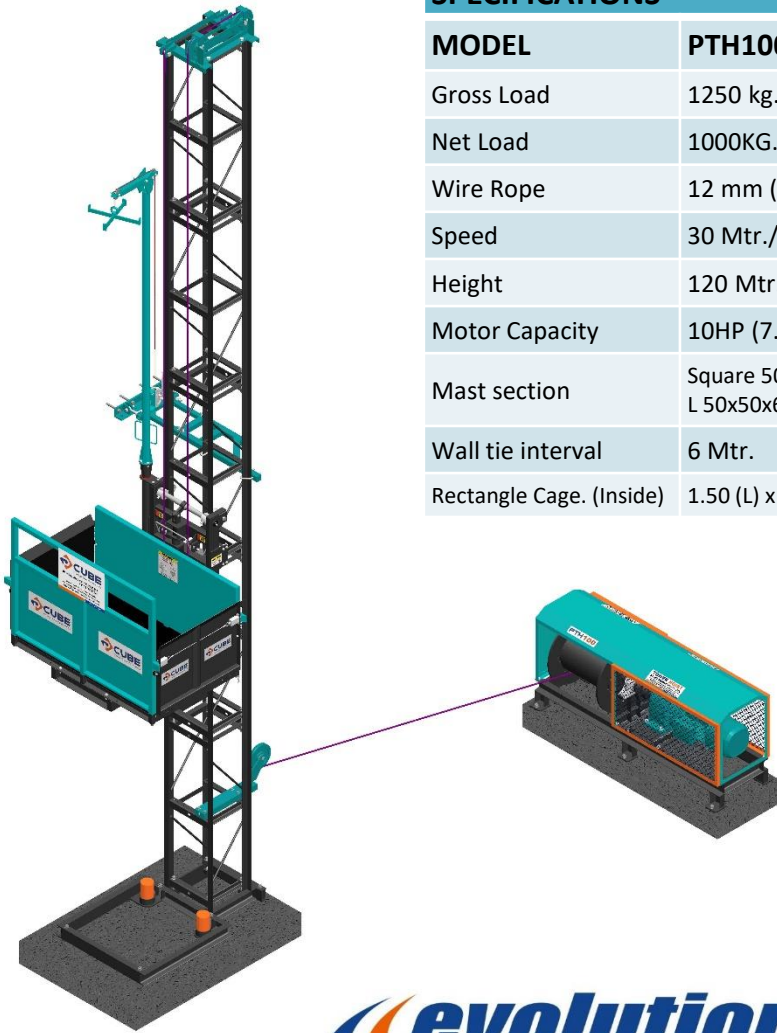

SPECIFICATIONS		
MODEL	PTH100	PTH150
Gross Load	1250 kg.	1500 kg.
Net Load	1000KG.	1200 KG.
Wire Rope	12 mm (6 X 36)	12 mm (6 X 36)
Speed	30 Mtr./ Min.	30 Mtr./ Min.
Height	120 Mtr.	120 Mtr.
Motor Capacity	10HP (7.5 KW) Brake Motor	12.5HP (9.3 KW) Brake Motor
Mast section	Square 500 mm x 400 mm x 1.5 Mtr. L 50x50x6 mm Angle	Square 500 mm x 400 mm x 1.5 Mtr. L 50x50x6 mm Angle
Wall tie interval	6 Mtr.	6 Mtr.
Rectangle Cage. (Inside)	1.50 (L) x 0.80 (W) x 0.7 (H) mtr.	1.50 (L) x 0.80 (W) x 0.7 (H) mtr.

SAFETY FEATURES

Power fail safe brake motor
Top limit
Bottom limit
Safety Brake
Fully Covered Wire Rope Drum
Fully Covered Electrical motor and Gear box.

OPTIONAL FEATURES

Concrete Bucket (Tilting Type)	300 Litres / 0.3 Cubic Meter
Rebar carrier	7 Mtr Lg. (Horizontal)
Floor Selection	Yes (Optional)
Erection Crane	Manual Type

STANDARD MATERIAL CAGE (RECTANGLE)

- **P CUBE Tower Hoist** is designed to offer the most cost efficient vertical transport solution on site and is delivered with 1000 KG & 1200 KG Net capacity with three phase brake motor.
- **P CUBE Tower Hoist** unit has Multi-Functionality, and can be used to transport either construction material or TMT bars.
- **Its robust and simple design makes it suitable for all vertical access, including direct access to the buildings for the new construction or refurbishment work.**
- **Safety is paramount** in all **P CUBE** machines. The **P CUBE Tower Hoist** conform to the **latest safety standards** i.e. **IS 12466 : 2012** which not only ensures safety of the operation but also lays down the requirements of capacity, construction, performance and testing of the Hoist.
- **Safety braking** of carriage shall be provided to cater the **wire rope failure**.

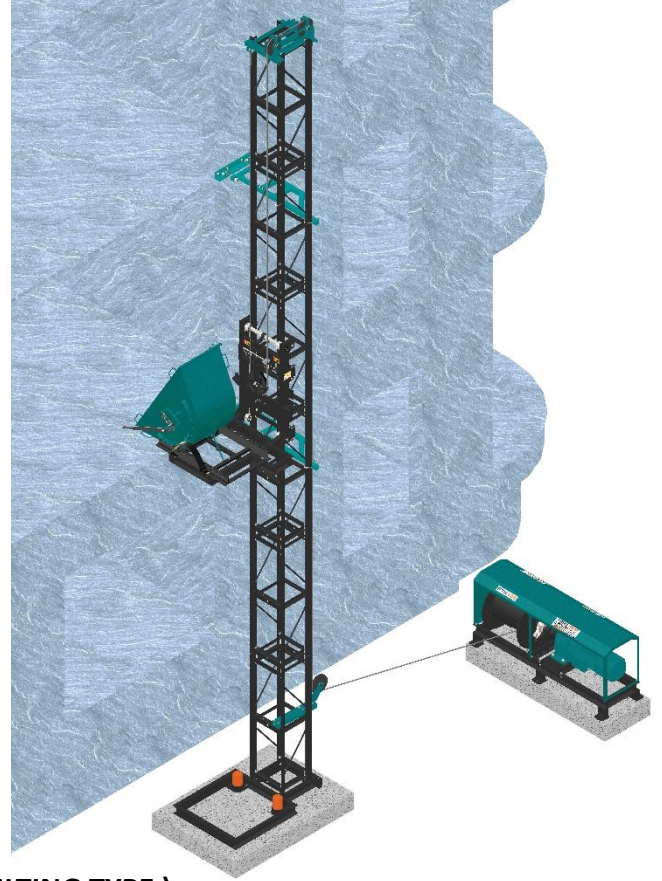
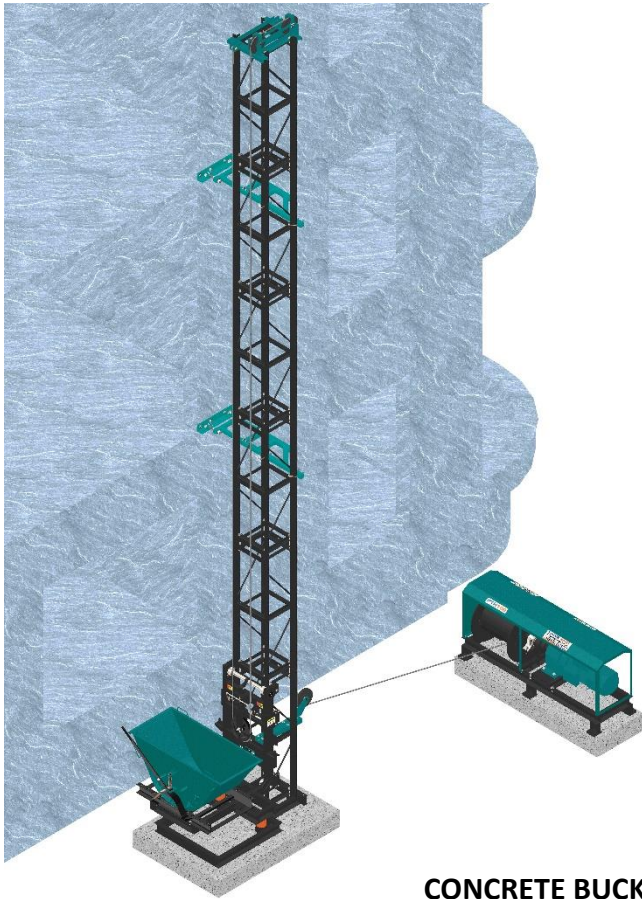

**CONCRETE BUCKET (TILTING TYPE)
(OPTIONAL)**

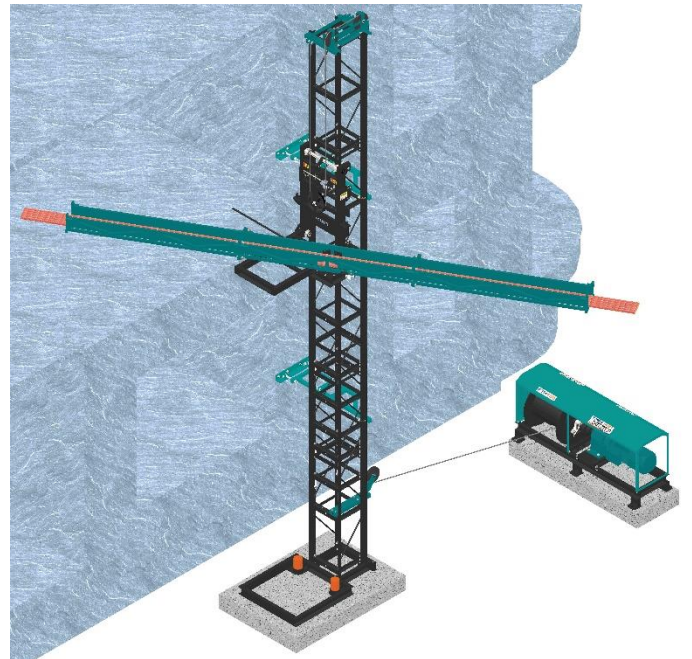
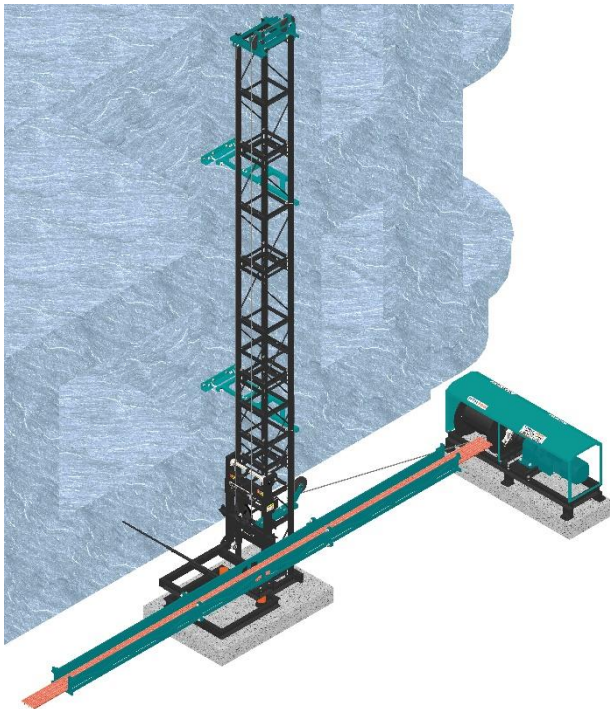

**HORIZONTAL REBAR CARRIER
(OPTIONAL)**

Multi-Functional Tower Hoist (Rack & Pinion)



GENERAL DATA		
MODEL	PRTH100	PRTH150
Gross Load	1000 kg.	1250 kg.
Net Load	750 KG.	1000 KG.
Gear Rack Module	5	5
Speed	30 Mtr./ Min.	30 Mtr./ Min.
Height	120 Mtr.	120 Mtr.
Mast section	Square 500 mm x 400 mm x 1.5 Mtr. L 50x50x6 mm Angle	Square 500 mm x 400 mm x 1.5 Mtr. L 50x50x6 mm Angle
Wall tie interval	6 Mtr.	6 Mtr.
Cable Guide Interval	6 Mtr.	6 Mtr.
Rect. Cage. (Inside)	1.5 (L) x 0.8 (W) x 0.7 (H) mtr.	1.5 (L) x 0.8 (W) x 0.7 (H) mtr.
ELECTRICAL DATA		
Motor Power	1 x 6.9 KW	1 x 9.5 KW
VFD	7.5 KW	11 KW
Power Supply	400V (±5%) 50 Hz	400V (±5%) 50 Hz

OPTIONAL FEATURES	
Concrete Bucket (Tilting Type)	300 Litres / 0.3 Cubic Meter
Rebar carrier	7 Mtr Lg. (Horizontal)
Erection Crane	Manual Type
Floor Selection	Yes
Load Cell	Yes (Optional)

SAFETY FEATURES	
Power fail safe brake motor	
European design Safety Device	
Cage doors limit switch	
Top limit switch	
Bottom limit switch	
Over travel final limits for top / bottom ends	
Rack searching limit	
Emergency stop (on car control boxes & Remote pendant)	
Power supply main switch	
Safety device actuation detector	
Fully Covered Gear box & Motor.	
Hand release break for Emergency reach to nearest lower floor.	

- **P CUBE Rack & pinion Tower Hoist** is designed to offer the most cost efficient vertical transport solution on site and is delivered 1000 KG & 1500 KG Gross capacity with three phase brake motor.
- **P CUBE Tower Hoist** unit has Multi-Functionality, and can be used to transport the construction material, TMT bars & concrete also.
- **Its robust and simple design makes it suitable for all vertical access, including direct access to the buildings for the new construction or refurbishment work.**
- **Safety is paramount** in all P CUBE machines. The P CUBE Tower Hoist conforms to the latest safety standards i.e. IS 12466 : 2012 which not only ensures the safety of the operation but also lays down the requirements of capacity, construction, performance and testing of Hoist.
- **European Centrifugal Safety Device** shall be provided to cater the high end safety against the free fall of machine.



Electrical Control Panel

- Schneider, Finder, etc premium and reliable brand switch gears.
- L&T / Schneider / Mitsubishi make VFD.
- Colour HMI display for ease of operation and maintenance.
- HMI & push button based operation.
- Fully automatic & Manual mode of operation.
- Encoder based floor selection system.
- Optional Overload protection system.
- Provide all required safety elements.
- IP 55 degree of protection.
- Clean and easy panel wiring with proper markings on cables for better traceability to reduce breakdown time.

Centrifugal Safety Device

- European design safety device is a mechanical unit which is used for the protection against accidental free-fall.
- Automatic reset: The procedure to reset the brake consists only in raising the hoist a few centimetres. The brake returns to its operative position again, without any need of the manipulation.

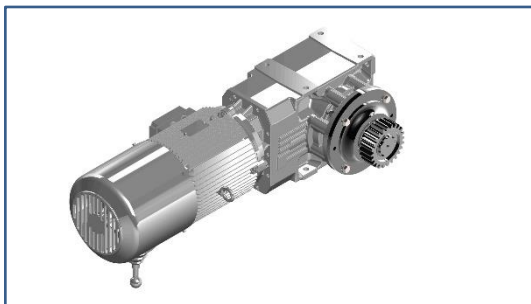

DRIVE UNIT

Type	Rack & Pinion
Gear Box	Bonfiglioli/Nord Germany Design Heli Bevel Geared Motor with Electromagnetic brake with the maximum power efficiency which reduces operating power of machine.
Location	Mount on Carriage unit

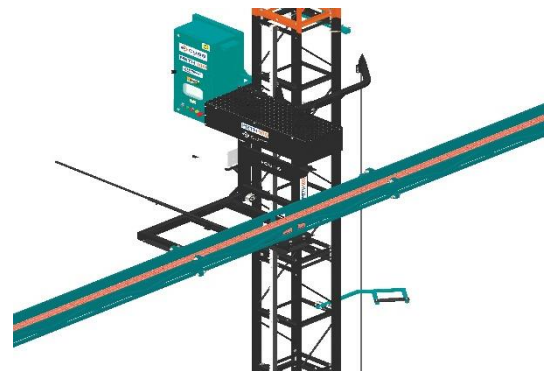

Concrete Bucket (Optional)

Type	Tilting type
Capacity	300 Ltr.

- Specially designed tilting type bucket to carry concrete.
- Robust 2.5mm thk. MS sheet bucket design.
- Self locking spring return lock arrangement.
- Easy tilting operation.
- Powder coated surface finish .

Rebar Carrier (Optional)

Type	Horizontal
Capacity	500 Kg. 7 Mtr. Long

- Special modular type tray design .
- Robust MS tube structure covered with MS sheets for tray.
- Swivel unit designed with Anti friction bearing for effortless pulling of long bars.
- Powder coated surface finish .

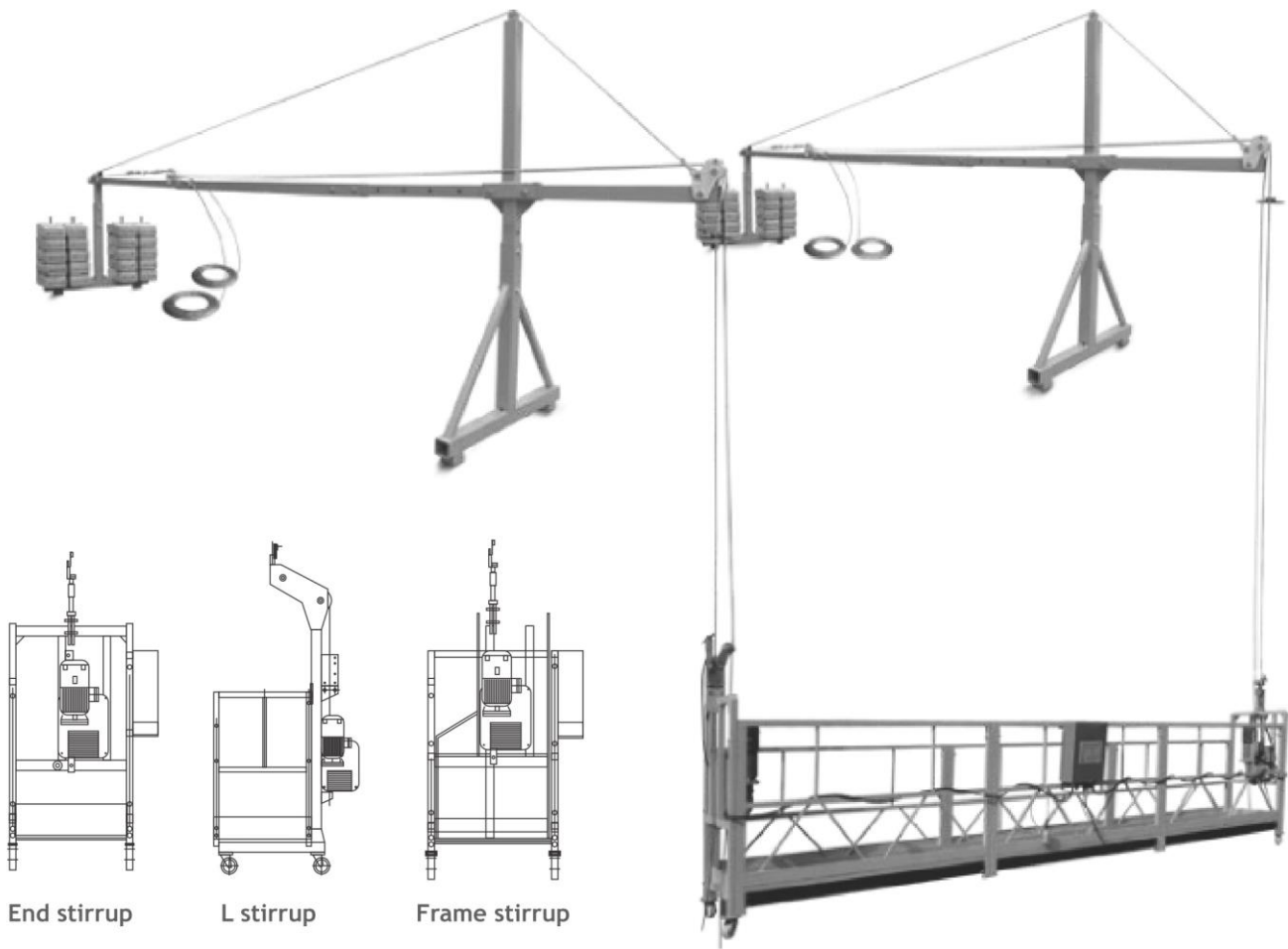

End stirrup

L stirrup

Frame stirrup

SRP Temporarily Suspended Platform

It takes men and materials up to the ideal working height to get the job done (Painting, welding, chimneys maintenance, bridge construction etc.) correctly and efficiently done.

- ✦ Time saving and cost saving alternative to tubular scaffolding
- ✦ Unlimited working height
- ✦ Quick and easy to assemble and install
- ✦ Light weight and easy to transport

It consists of :

- ✦ Steel platform
- ✦ Motorized traction hoists and controls
- ✦ Steel wire ropes attached to a roof suspension system

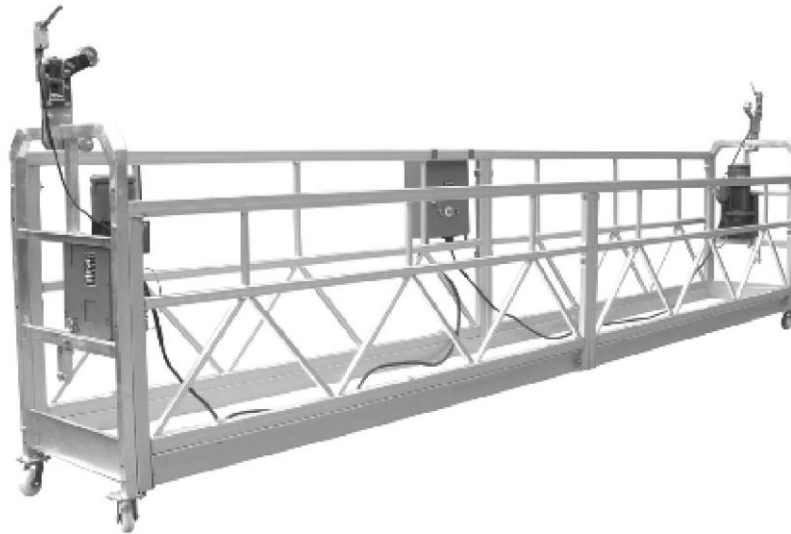

Main technical parameters

Item		Model and parameters		
		SRP 800	SRP 1000	
Rated load		800kg	1000kg	
Ascend speed		9~11m/min	9~11m/min	
Suspended Platform size (L× W)		(2.5m× 2+1.5+1) × 0.69	(2.5m× 2+1.5+1) × 0.69	
Wire rope		4× 31SW+FC-9.1	4× 31SW+FC-10.2	
Hoist	Hoist model	LTD80	LTD100	
	Rated lifting force	8kN	10kN	
	Electric Motor	Type	YEJ2-90L-4D	YEJ2-90L-4D
		Power	1.8kW	2.0kW
		Voltage	AC415V	
Braking torque		15.2 N•m		
Safety lock type		Tilt-proof safety lock		
Suspension mechanism	Height adjustment	1.15m~1.75m		
	Front beam extent	1.1m~1.7m(should reduce the load on the suspended platform when extent is 1.5m or more)		
Machine weight	Suspended platform (including hoist, safety lock, electric control box)	545kg	610kg	
	Suspension mechanism	2× 170kg		
	Balance weight	1000kg	1200kg	
	Whole machine weight (no-including wire rope and cable)	1885kg	2150kg	

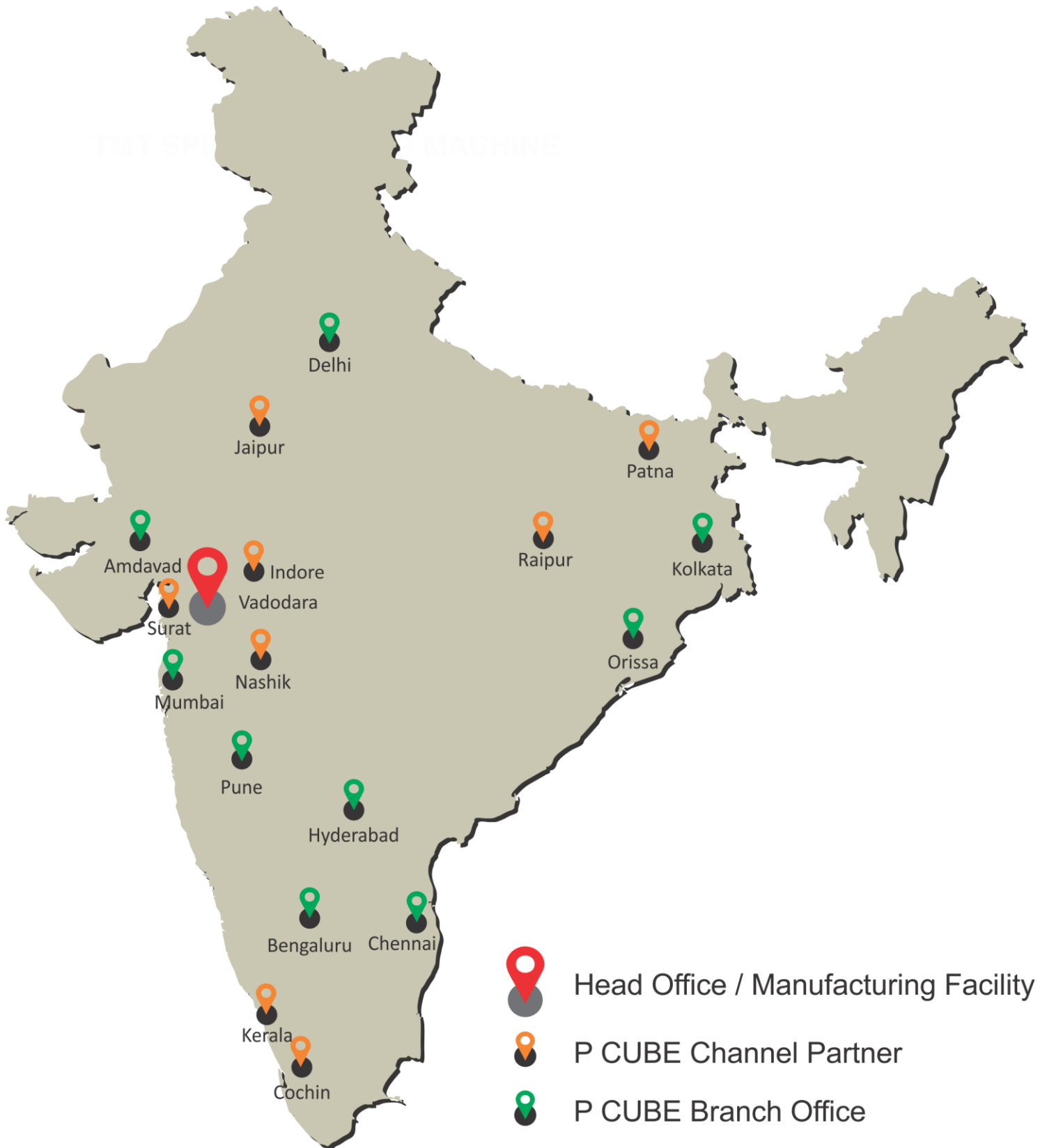

P CUBE EQUIPMENTS PVT. LTD.

Head Office : Survey No.49-50 Hari Industrial Park, Por-Ramangamdi Road ,Por, Dist. Vadodara-391 243. (Gujarat) INDIA.

Mob. : Spares & Service - +91 78742 33331, New Enquiry - +91 78742 33332 **Email :** sales@pcubeindia.com

Branch Office : New Delhi | Bangalore | Hyderabad | Chennai | Kolkata | Pune | Mumbai | Ahmedabad | Orissa

Domestic Dealers : Surat | Nashik | Indore | Cochin | Jaipur | Patna | Raipur | Kerala